

Chesterton Connect™

USER GUIDE

Equipment Monitoring Sensor – Vibration, Temperature, and Pressure



Please read this user guide in its entirety before proceeding with the installation of the sensor. It is assumed that the user is familiar with the equipment and will take all the necessary safety precautions before attempting to install this sensor and its components. Caution must be taken to install the product using safe and best practice methods.

TABLE OF CONTENTS

<i>About the Chesterton Connect™ sensor</i>	2
<i>About the Chesterton Connect™ app</i>	2
<i>Warnings and cautions</i>	2
<i>Specifications and limits</i>	3
<i>Software features</i>	3
<i>Operating parameters</i>	3
<i>Statements</i>	3
<i>Sensor details</i>	4 – 5
<i>Components</i>	4
<i>Vibration axes</i>	4
<i>LED alert system pattern</i>	4
<i>Dimensions</i>	5
<i>Installation instructions</i>	6
<i>Tools required</i>	6
<i>Installation</i>	6
<i>App instructions</i>	7 – 18
<i>Connect to sensor</i>	7
<i>Registering your new sensor</i>	8 – 9
<i>Pairing to sensor</i>	9
<i>Establishing measurement limits</i>	10
<i>Establishing measurement rates</i>	11
<i>Sensor app main screen</i>	11
<i>Retrieving measured data</i>	12
<i>Graph measured data</i>	13
<i>Export the measured data</i>	14
<i>Alarm clearing</i>	15
<i>Change measuring units</i>	16
<i>Finding your sensor</i>	17
<i>Removing sensor from the mobile app</i>	18
<i>Troubleshooting</i>	19
<i>Battery replacement</i>	19
<i>Power cycling</i>	19
<i>Factory resetting</i>	19
<i>Limited warranty</i>	20
<i>Privacy policy</i>	20

About the Chesterton Connect™ sensor

Chesterton Connect is a 24/7 conditioning monitoring system that enables users to monitor process and equipment operating conditions. Chesterton Connect makes it simple and easy to monitor:

- 3-axis vibration
- Surface temperature
- Process temperature
- Process pressure

Chesterton Connect is aimed at equipment performance optimization, helping prioritize which equipment needs attention. The mobile app and unit's LED indicator alert the user of any vibration, temperature or pressure variations from the user programmed parameters. These alerts can help establish more efficient maintenance plans to help reduce unplanned downtime and asset failure.

About the Chesterton Connect™ app

Chesterton Connect communicates via Bluetooth® with its companion mobile app to display alerts and measured data. The Chesterton Connect app is a user-friendly mobile application that allows the user to visualize the data collected from the sensor. In addition, the app allows the user to connect to multiple sensors providing a comprehensive view of a plant's equipment health. The app lets the user set equipment parameters limits. The data can be exported for analysis helping the user understand the equipment's operation and take preventative actions to extend productivity.

Software requirements (operating system):

- Android version 6.0 and up
- Apple version 10 and up
- Bluetooth version 4.0 and up

The Chesterton Connect app is available as a free download:



Warnings and cautions

- Chesterton Connect contains a replaceable lithium thionyl chloride battery and a neodymium magnet. Follow local laws for proper treatment and disposal of this product or its components.
- To reduce the risk of fire or burns, do not crush, puncture, expose to temperatures above 85°C (185°F) or dispose of in fire.
- Chesterton Connect contains a very strong neodymium magnet. Use caution when handling unit to avoid injuries.
- Disable the product if it is damaged or operates incorrectly.
- Do not stick anything into the pressure/temperature 1/4" NPT port.
- Handle the unit using the supplied ESD protective caps until ready to install.
- Make sure product is used as specified and within its advertised operating limits.
- Do not bend cable beyond its bend radius.
- Do not allow the pressure/temperature sensor to come in contact with the magnet.
- Do not drop magnet against hard surfaces, including the pump.
- Do not drop the Chesterton Connect product. Dropping the product may affect its ability to function properly.
- Follow all nearby Personal Protective Equipment (PPE) and equipment safety requirements when installing, troubleshooting or removing the sensor and its components.
- If using the Pressure/Temperature (P/T) sensor, ensure the process fluid is compatible with the stainless steel P/T sensor.

Specifications and limits

SOFTWARE FEATURES

- **Security:** Encrypted setup and password protected operation
- **Personalization:** Configurable name and usage information
- **Data acquisition:** Monitoring mode for extended battery life (5-minute intervals) and high accuracy mode for troubleshooting (1 minute intervals)
- **Data storage:** Up to 30 days of rolling history
- **Alerts:** Configurable thresholds, alarms, and user defined maintenance events
- **Analytics:** Time plotted trends and analysis
- **Data export:** Email export of sensor data and alarms

OPERATING PARAMETERS

Note: Product is not certified as intrinsically safe.
Parameters are based on laboratory testing.

- **Pressure sensor limit:** 68 bar g (1000 psig)
- **Temperature limit (body):** -20°C – 85°C (-4°F – 185°F)
- **Temperature limit (sensor):** -20°C – 125°C (-4°F – 257°F)
- **Vibration sensor:** 3-axis accelerometer ±16g
- **Battery:** 3.6V lithium thionyl chloride battery (replaceable)
- **Fitting:** 1/4" NPT 316SS connection
- **Mount:** Magnetic mounting base (additional mounting options sold separately)
- **Certifications:** FCC, IC, RoHS, IP66, NSF61, and ACS

Statements

FCC Compliance Statement

This device complies with Part 15 of the FCC Rules. Operation is subject to the following two conditions:

- (1) this device may not cause harmful interference, and
- (2) this device must accept any interference received, including interference that may cause undesired operation. No changes shall be made to the equipment without the manufacturer's permission as this may void the user's authority to operate the equipment. This device has been designed and complies with the safety requirements for portable RF exposure in accordance with FCC rule part 2.1093 and KDB 447498 D01.

RSS Compliance Statement

This device complies with Industry Canada's license-exempt RSSs. Operation is subject to the following two conditions:

- (1) This device may not cause interference; and
- (2) This device must accept any interference, including interference that may cause undesired operation of the device. This device has been designed and complies with the safety requirement for RF exposure in accordance with RSS-102, issue 5 for portable conditions.

EN 61326-1:2013 Radiated Immunity: Unit may experience temporary loss of function during interference.

Country of Origin: Made in the USA

Sensor details

COMPONENTS

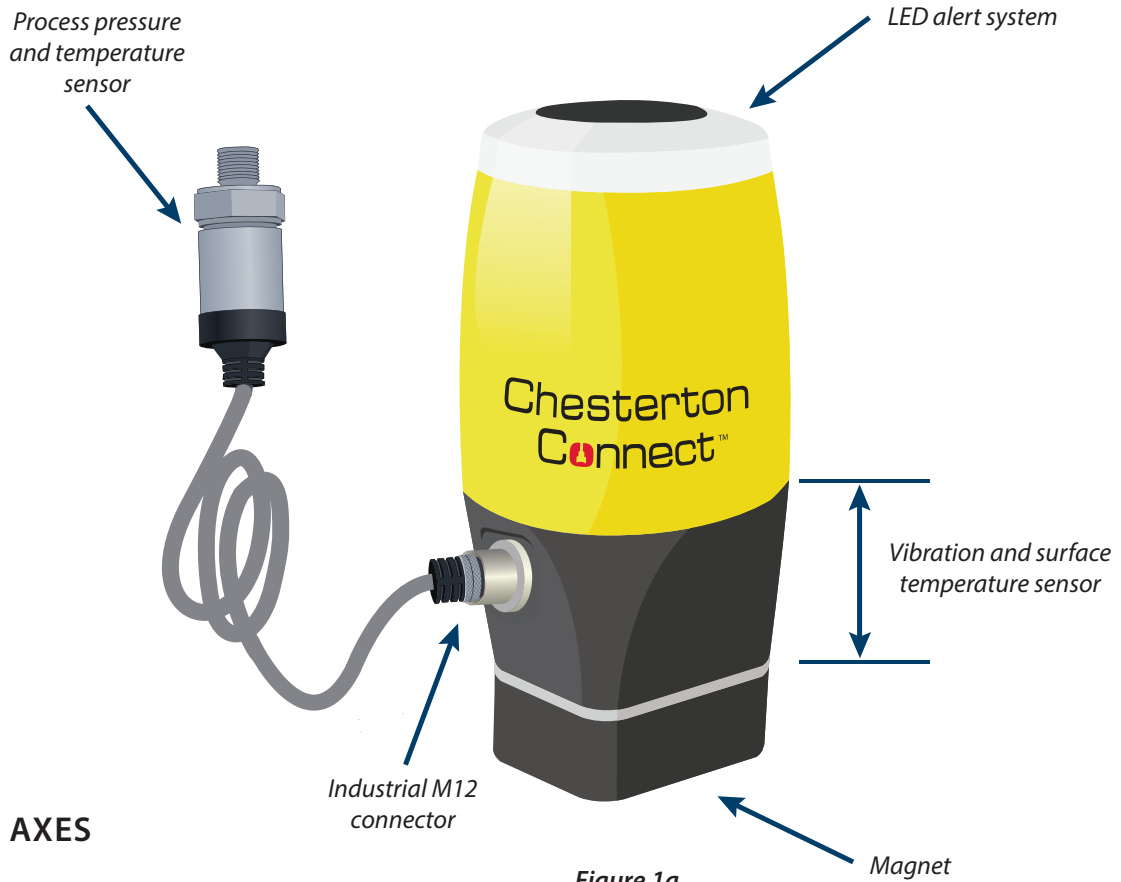

Figure 1a

VIBRATION AXES

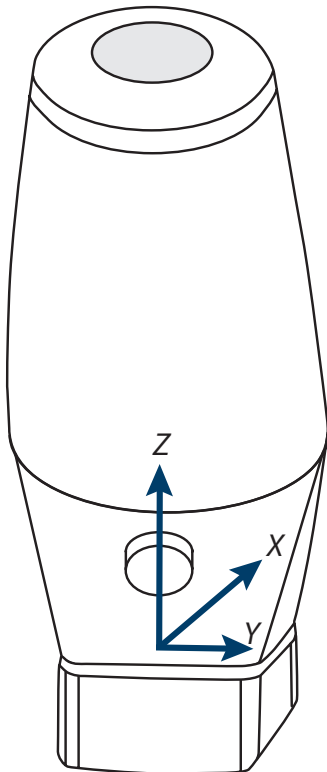







Figure 1b

LED ALERT SYSTEM PATTERN

LED color			Alarm type
	+		Powered on and operating correctly
			Mobile app connection to the sensor Data "SYNC" Sensor "identify"
			Measurement outside established limits set by user
15 second intervals			

Sensor details (continued)

DIMENSIONS

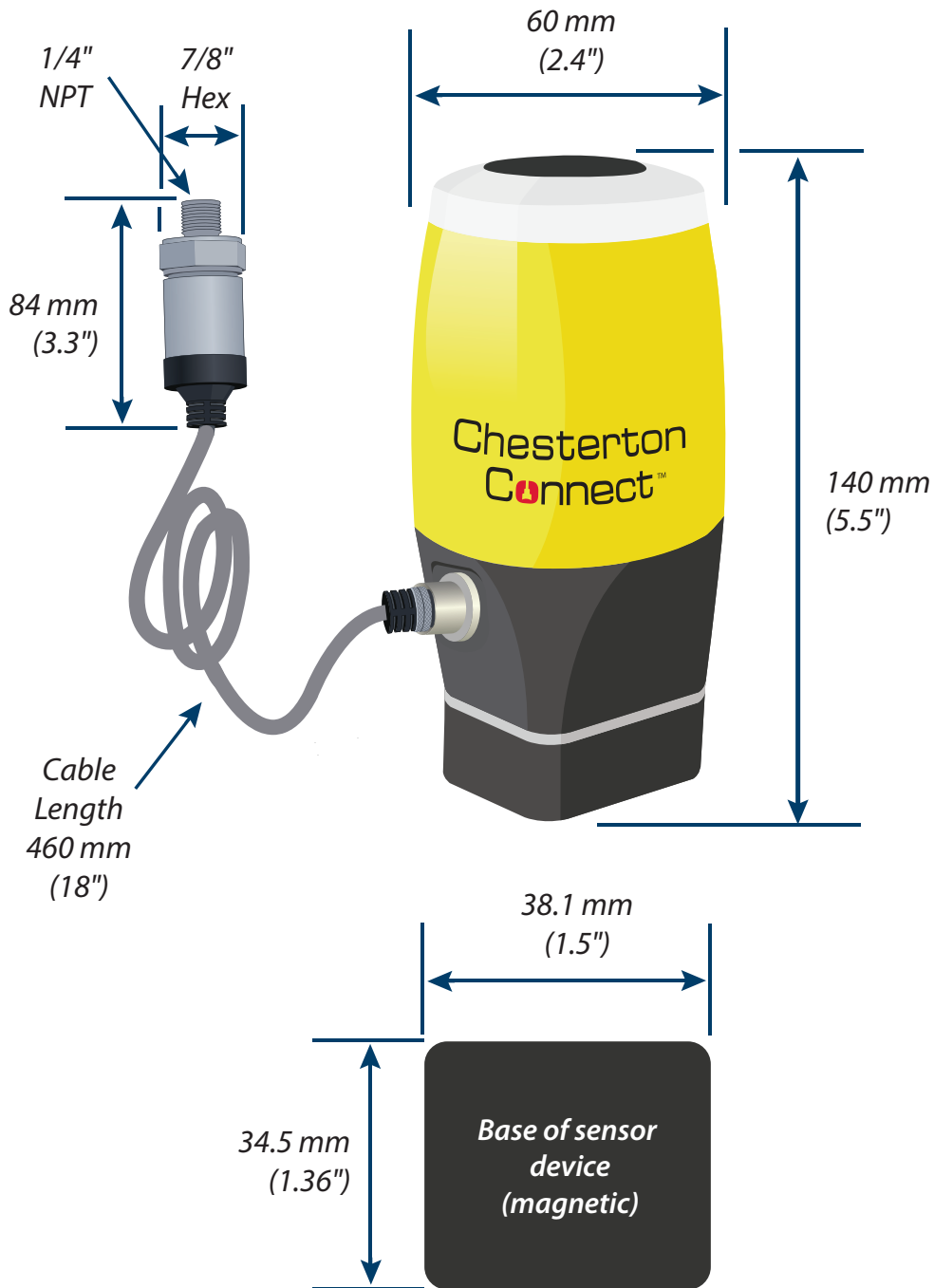

Figure 2

Installation instructions

TOOLS REQUIRED



Thread sealant tape

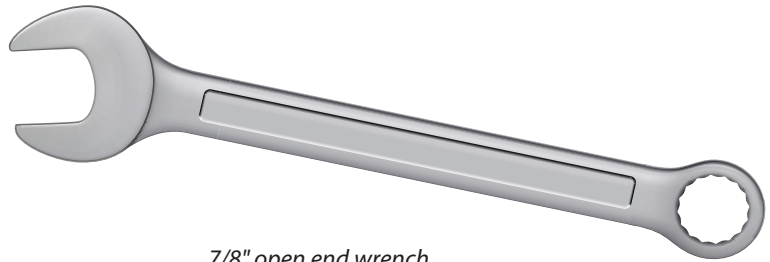

7/8" open end wrench

INSTALLATION

Warning: the magnet is extremely strong, attach at a 45° angle then flatten to the surface. Do not "drop" the magnet to the pump.

1. If using the Pressure/Temperature (P/T) sensor, ensure the process fluid is compatible with the stainless steel P/T sensor.* In addition, ensure process fluid temperature and pressure are within specified sensor limits (see page 3 for P/T sensor specifications limits). Follow the applicable lock out/tag out procedure for the equipment and make sure all PPE and safety precautions are followed.

Apply thread sealant to the 1/4" NPT connector. The 1/4" NPT connector can be installed on the:

- Pump suction
- Pump discharge
- Tee into double mechanical seal barrier or buffer fluid
- Connected to extra flush port or tee into flush of pump or mechanical seal

Tighten the 1/4" NPT 1.5 to 3 Turns From Finger Tight (T.F.F.T.) or approximately 25 ft-lb (see figure 3). *Note: Torque depends on different parameters such as sealing material, mating material, thread lubrication and pressure level.*

2. Attach the M12 pin connector to the base unit** (this will activate the unit). Turn the connector nut until it is finger tight. The LED alert system will flash red, green, blue, and green (again) when activated.
3. The base of the unit is magnetic. Install the unit on the surface where vibration and surface temperature will be measured*** (see figure 4 for preferred sensor location on pumps). Take care in selecting a safe stationary location to mount the unit. Ensure the operating temperatures do not exceed the rated temperature of the body 85°C (185°F).

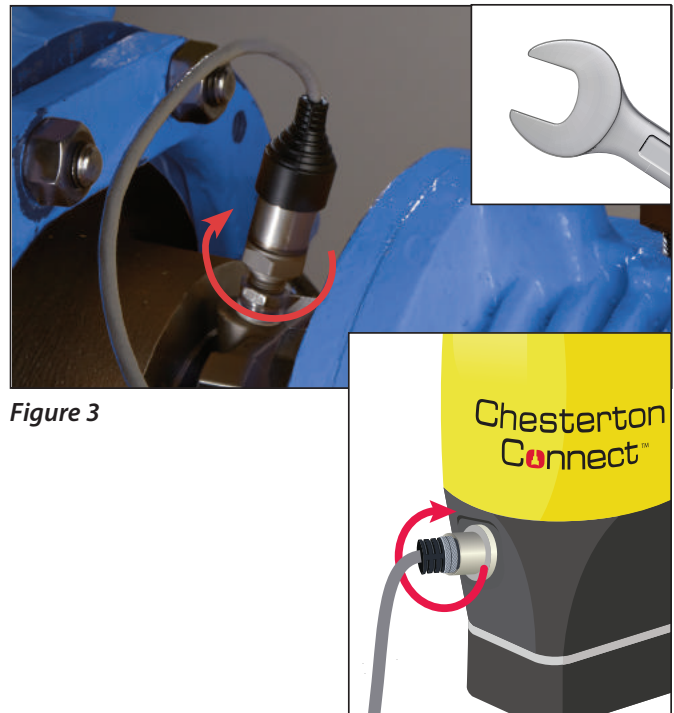

Figure 3

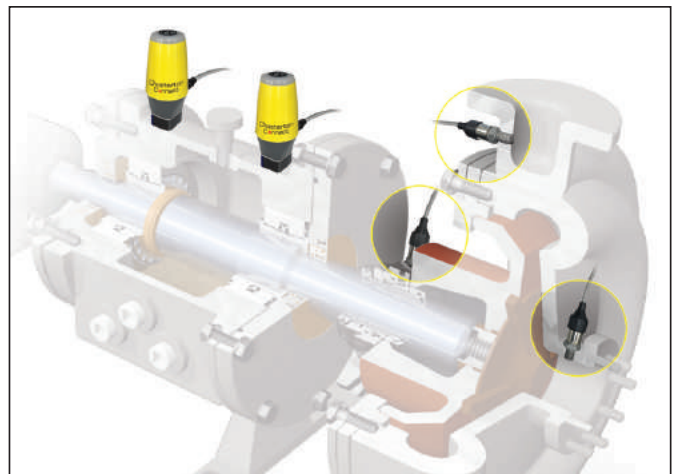

Figure 4

* Pressure port is a dead-ended component and must be inspected as part of the plant's maintenance plan to ensure no debris, slurry, or solidified process clogs the pressure port in the sensor head.

** An extension cable (sold separately) can be added to the P/T sensor. Only 1 (one) extension cable is recommended per sensor. For applications requiring additional extension cables please contact our customer support (see page 20)

***It is recommended in critical applications, additional tethers or attachment methods be used to ensure the telemetry head stays attached to the equipment.

App instructions

CONNECT TO SENSOR

1. Download and open the mobile app, "Chesterton Connect". The app can be downloaded from Apple or Android mobile platforms.

Software requirements (operating system):

- Android version 6.0 and up
- Apple version 10 and up
- Bluetooth® version 4.0 and up

2. Make sure "Bluetooth" is enabled on the mobile device and you are within the required range of 20 m max (~ 65' max) distance from the sensor.

3. Chesterton Connect™ communicates with the mobile device via Bluetooth. To enable Bluetooth scanning, it is required to allow the Chesterton Connect app to access the mobile device's location (see figure 7).

4. If sensor is not found, check the following:

- Bluetooth is turned on.
- M12 connector is connected to the unit and the unit is on. The unit's LED alert system will flash green every 30 seconds if the unit is "on" but not connected to the mobile device.
- You are in range of the sensor, 20 m (~ 65')

The Chesterton Connect app is available as a free download:

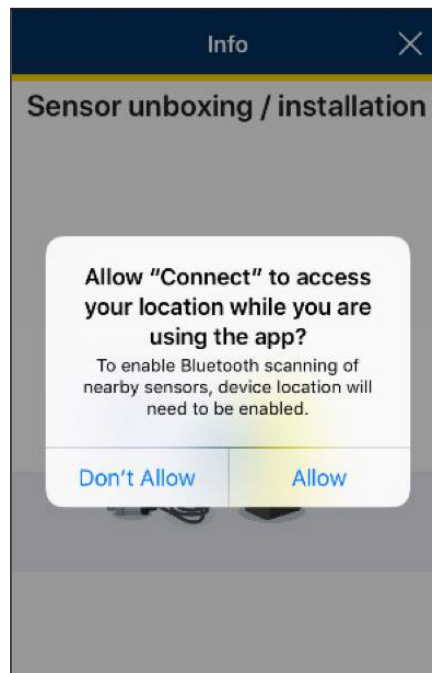

Figure 7

App instructions (continued)

REGISTERING YOUR NEW SENSOR

Note: Each sensor requires a password to access the sensor settings, and to retrieve stored data.

Once the sensor is connected to the mobile device is time to register your new sensor.

1. Select the new “unregistered” sensor (see figure 8).
2. Enter a unique password for your sensor.
3. Retype your password.
4. Select **Next** (see figure 9).

Note: Password requirement is 20 characters max and only ASCII characters (shown below).

`!"#$%&'()*+,-./0123456789;<=>?@ABCDEFGHIJKLMNQRST
UVWXYZ[\]^_`abcdefghijklmnopqrstuvwxyz{|}~`

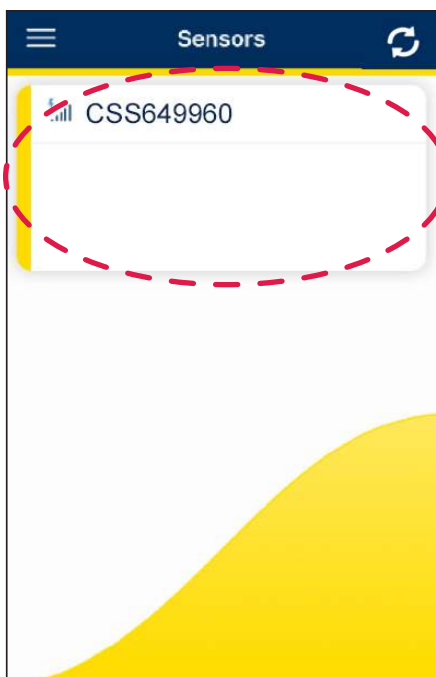

Figure 8

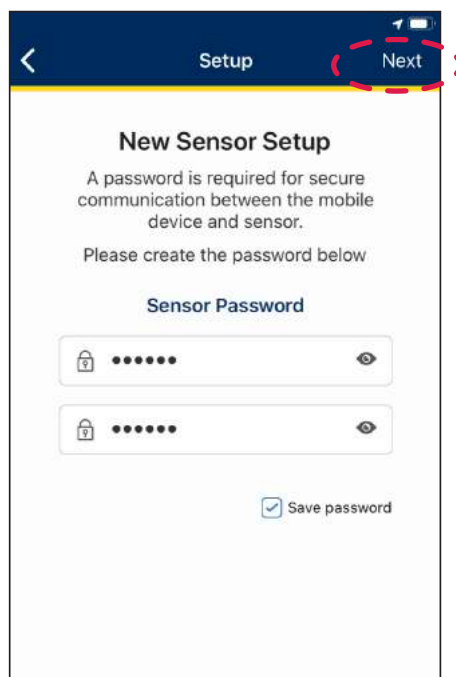

Figure 9

App instructions (continued)

REGISTERING YOUR NEW SENSOR

5. The unit will create a generic name. Change the name for better identification, then fill out the sensor data. This will help you to better track your measured data (see figures 10 – 12).

6. Once all fields are completed, select **Save**.

Setup Save

Sensor Information
(Special character restrictions apply)

Sensor Name
CSS649960

Equipment Identification
Asset Tag #

Equipment Type
Equipment Type

Sensor Location
Seal Flush Port

Company Name
Company Inc.

Figure 10

Setup Save

Sensor Information
(Special character restrictions apply)

Sensor Name
Pump 1

Equipment Identification
Pump#34

Equipment Type
Centrifugal Pump

Sensor Location
Flush Port

Company Name
Company ABC

Figure 11

Setup Save

Pump 1

Equipment Identification
Pump#34

Equipment Type
Centrifugal Pump

Sensor Location
Flush Port

Company Name
Company ABC

Contact
your.name@companyABC.com

Figure 12

PAIRING TO SENSOR

Using Bluetooth®, pair your phone with your sensor unit (see figure 13).

Ensure the following for easy pairing:

- Bluetooth is enabled on your phone
- You are in range of the sensor, 20 m (~ 65')

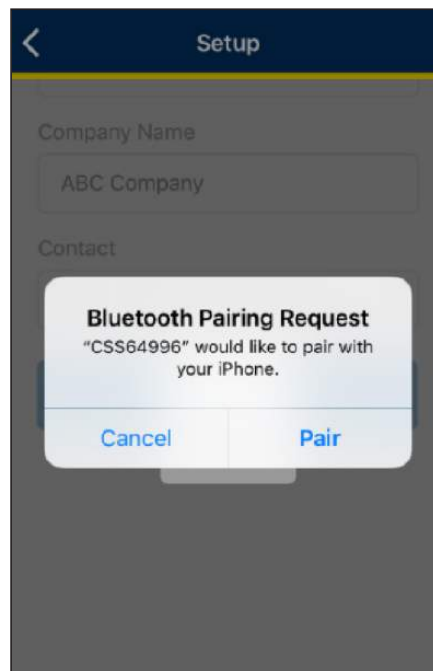

Figure 13

App instructions (continued)

ESTABLISHING MEASUREMENT LIMITS

The sensor alarms are disabled by default. You can change the sensor alarm parameters directly through the mobile app.

1. Select **Settings** (see figure 14).
2. Select **Configure Alarms** (see figure 15).
3. Alarms are disabled by default (greyed out). Tap on the empty checkbox above the slider to enable the alarm. Then adjust the slider to establish the min/max limits for your sensor (see figure 16). If measurements go above/below these limits, the Mobile App and in-unit LED alert system will alert you of any undesirable events.
4. Select **Save**.

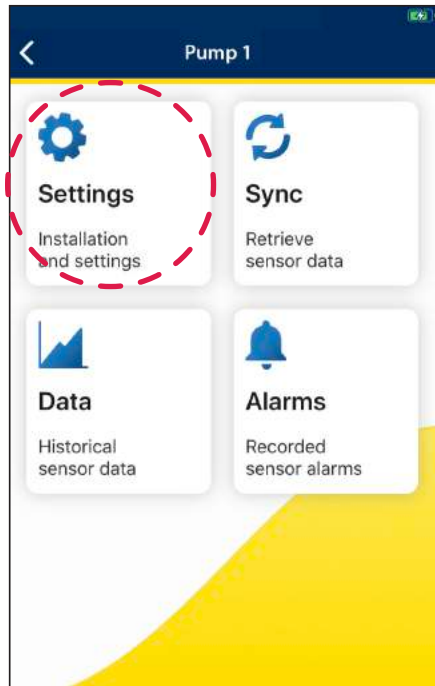

Figure 14

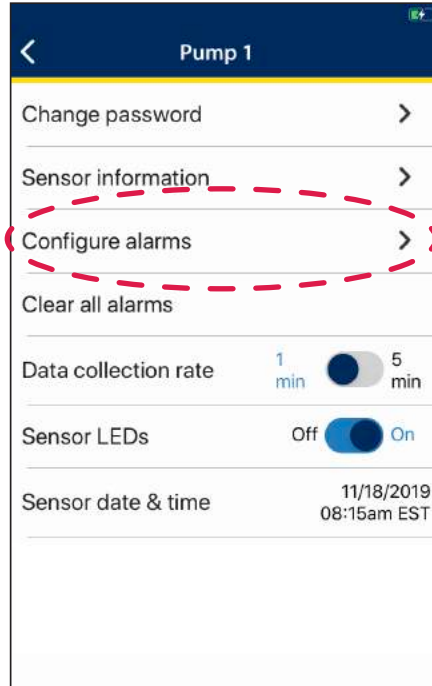

Figure 15

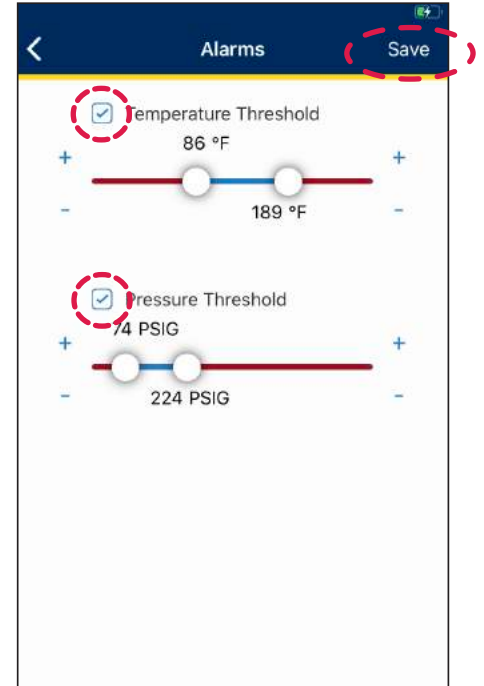

Figure 16

App instructions (continued)

ESTABLISHING MEASUREMENT RATES

Chesterton Connect™ has two modes of data collection:

Fast (1 min): monitors the equipment condition every one minute. This can be used for fast critical diagnostics of your rotating equipment. *Battery life will be reduced when capturing data at this rate.*

Standard (5 min): monitors the equipment condition every five minutes. This is considered the standard operation for continuous monitoring. *Battery life is normal.*

To change the data collection mode follow these steps:

1. Select **Settings** (see figure 17).
2. Toggle the **Data Collection Rate** button to desired measurement rate (see figure 18).

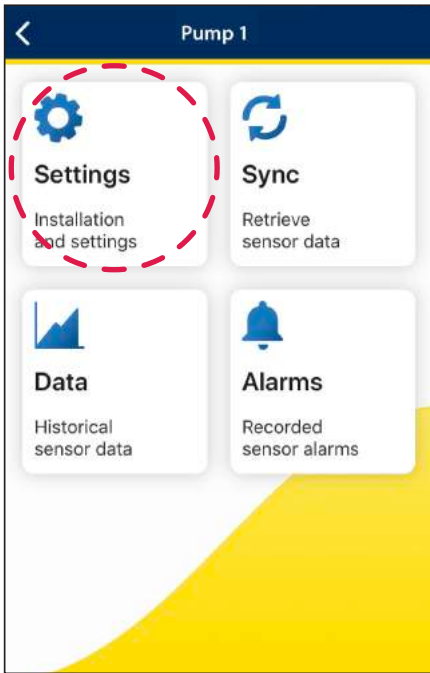

Figure 17

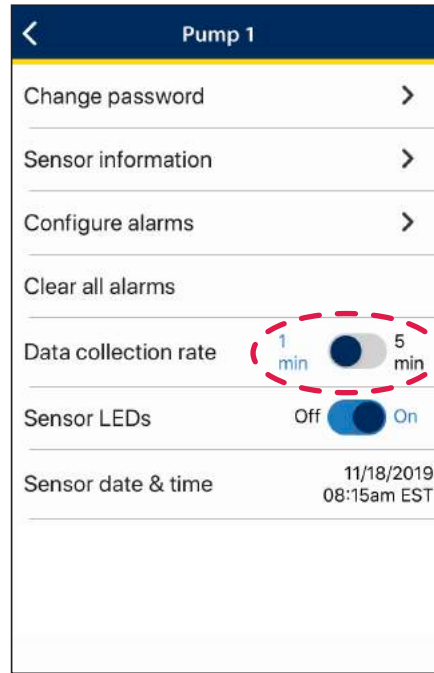
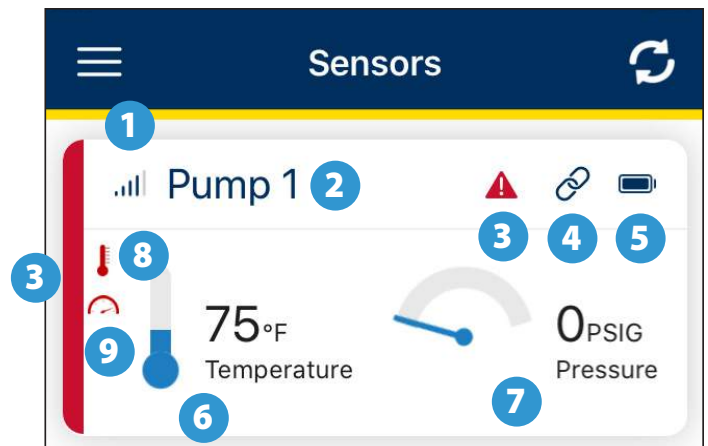

Figure 18

SENSOR APP MAIN SCREEN

- 1 Signal strength indicator, the closer you are to the sensor the stronger the signal
- 2 Sensor name
- 3 Alert indicators
- 4 Indicator if someone else is connected to the sensor (only one connection at a time is permitted)
- 5 Battery life indicator
- 6 Process temperature (updated every 5 seconds)
- 7 Process pressure (updated every 5 seconds)
- 8 Process temperature alert
- 9 Process pressure alert



App instructions (continued)

RETRIEVING MEASURED DATA

Note: If the sensor was not registered in your mobile device, a password will be required to sync the measured data.

1. Select the sensor you want to retrieve the measured data from (example on figure 19).
2. Select **Sync** (see figure 20).

3. Use the drop down menu to select the time period for data retrieval (see figure 22).

4. Select **Sync** (see figure 23).

Once the measured data is synced, the app will automatically go back to the main menu.

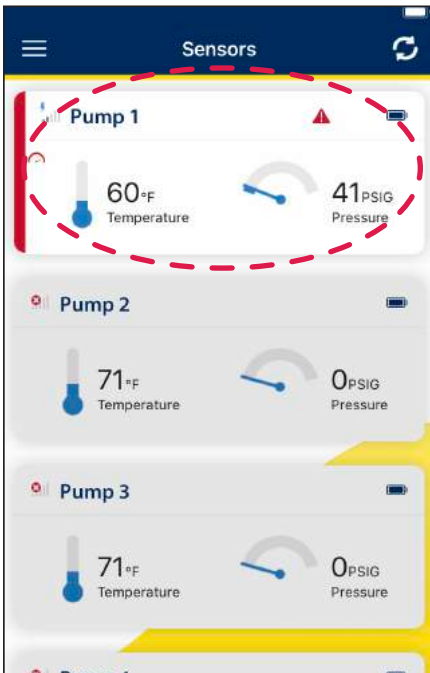

Figure 19

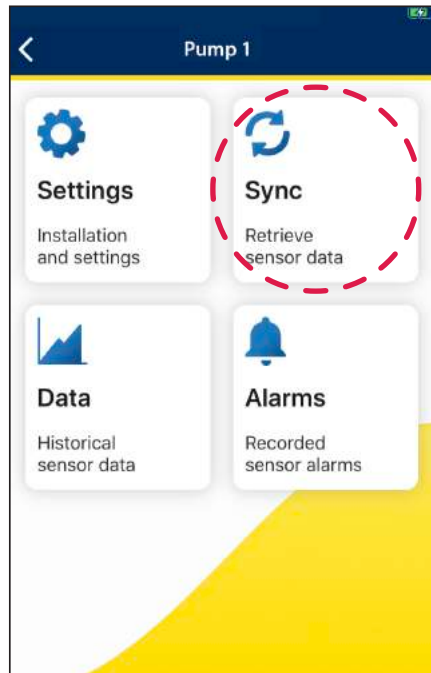

Figure 20

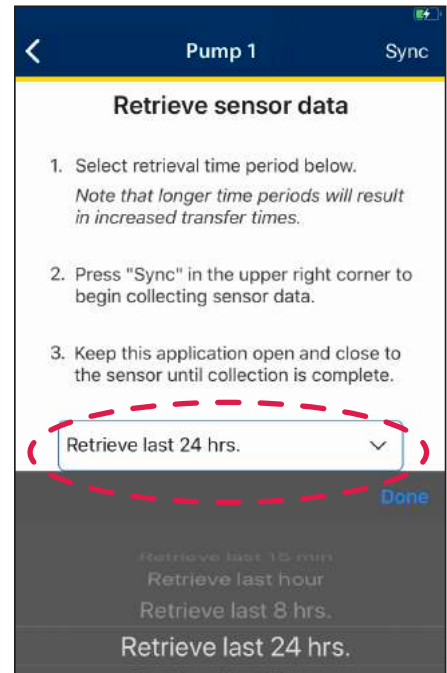

Figure 22



Figure 23

App instructions (continued)

GRAPH MEASURED DATA

Note: Sensor data must be synced to mobile app to view graphed data.

1. Choose the sensor you want to view the measured data from (see figure 24).
2. Select **Data** (see figure 25).

Options for the graph (see figure 26):

- Turn on/off the measured variables: **process temperature, surface temperature, process pressure, and vibration** (see the bottom of figure 26).
- **Zoom in/out** each measurement, by using pinch motion.
- **Double tap** the screen to go back to full graph view or focus on a specific selected measurement.

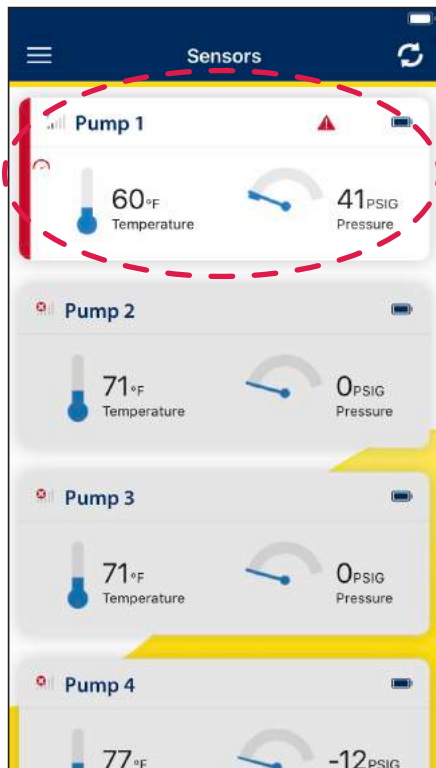

Figure 24

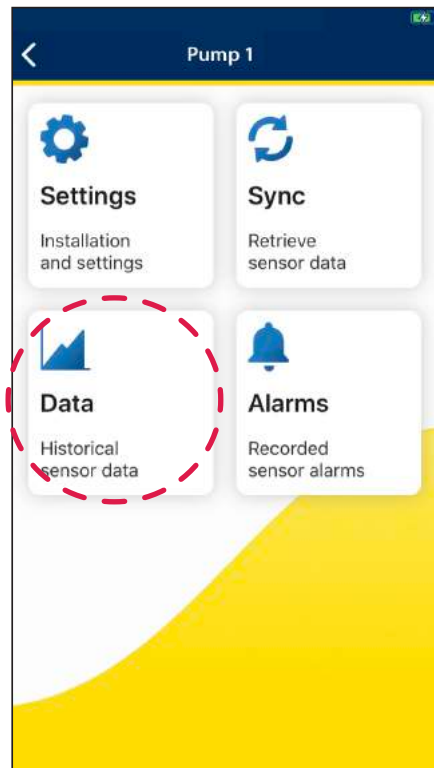

Figure 25



Figure 26

App instructions (continued)

EXPORT THE MEASURED DATA

1. Choose the sensor you want (see figure 27) to view the measured data from. Then select **Data** (see figure 28).
2. Select **Export** (see figure 29). The tabulated measured data will be shown.
3. Select **Share** (see figure 30).
4. Select your preferred sharing method.
5. Follow the instructions of the selected share method.

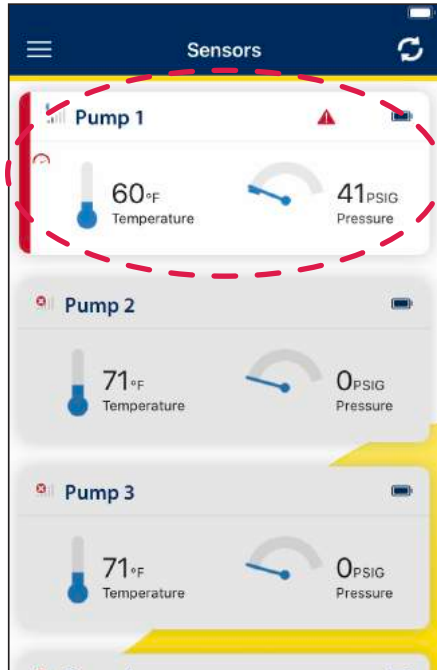

Figure 27

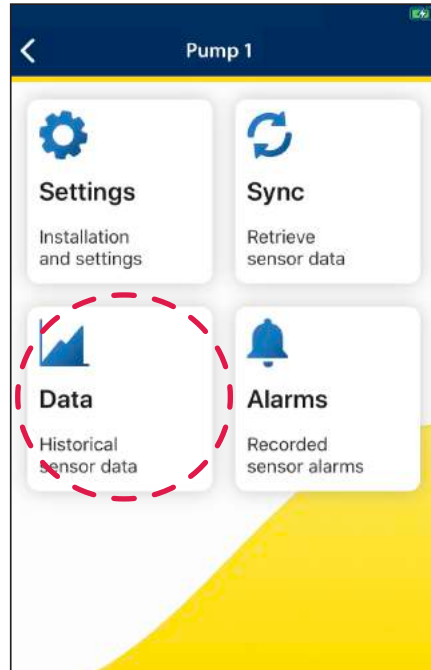

Figure 28

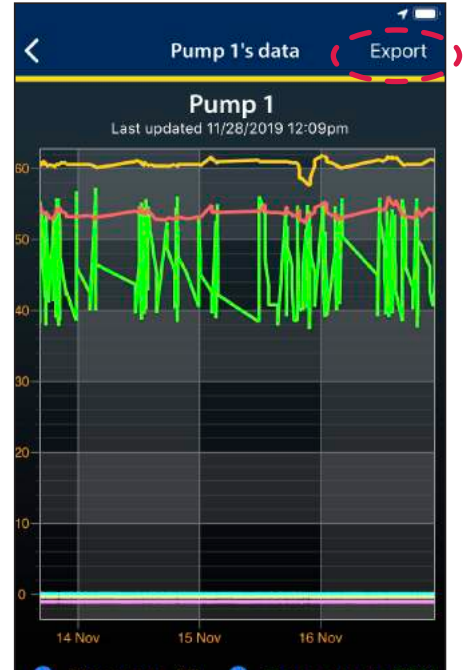

Figure 29



Figure 30

App instructions (continued)

ALARM CLEARING

An alarm is triggered if measurements are recorded outside the established limits. Once the measurements return to being inside the established limits, the mobile app and unit's LED indicator will remain in an alert state until the alarms are cleared.

Note: If measurements are still outside the established limits, the alarm will reactivate. Clearing alarms will not delete or reset alarm limits previously established.

There are two ways to clear alarms:

Option A

1. Swipe left on the desired sensor. The identify/clear alarm option will appear (see figure 31).
2. Tap to select **Clear Alarm** (figure 31).

Option B

1. Select **Settings** (see figure 32).
2. Select **Clear All Alarms** (see figure 33).

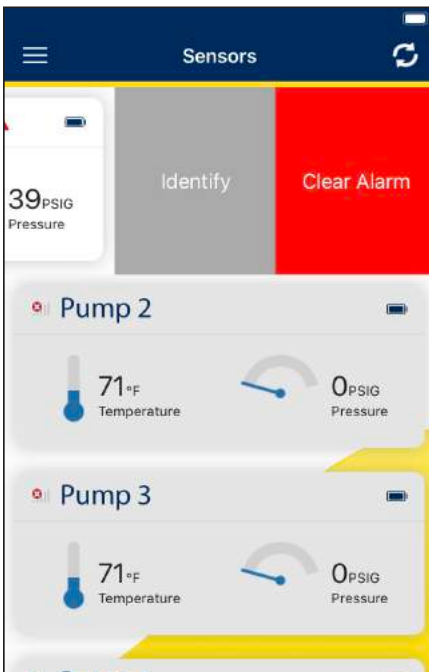

Figure 31

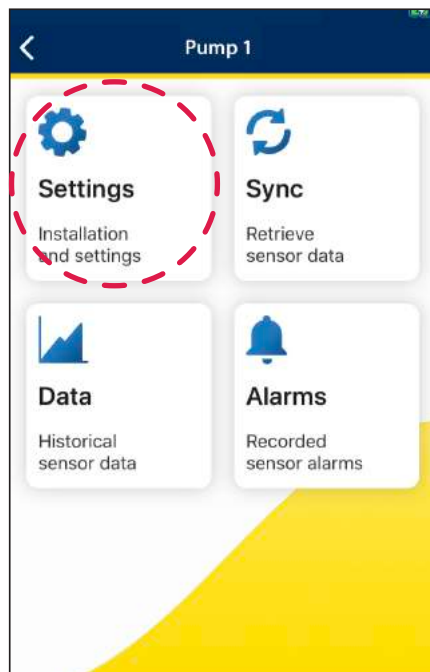

Figure 32

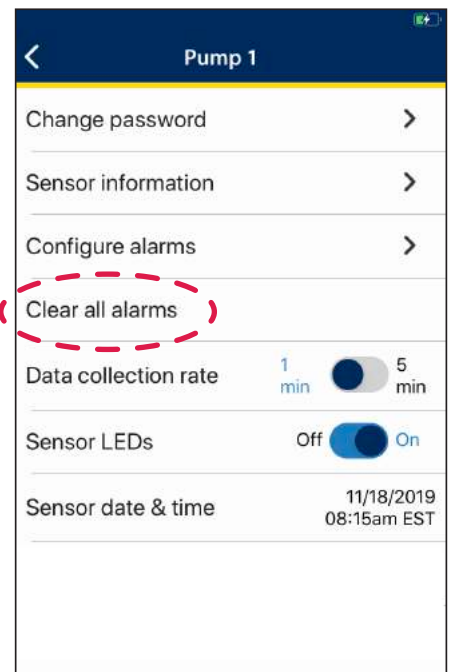

Figure 33

App instructions (continued)

CHANGE MEASURING UNITS

1. Select the **Menu icon** (see figure 34).
2. Select **App settings** (see figure 35).
3. Use the drop down menu to select the preferred **Temperature, Pressure, and Vibration units** (see figures 36 – 39).

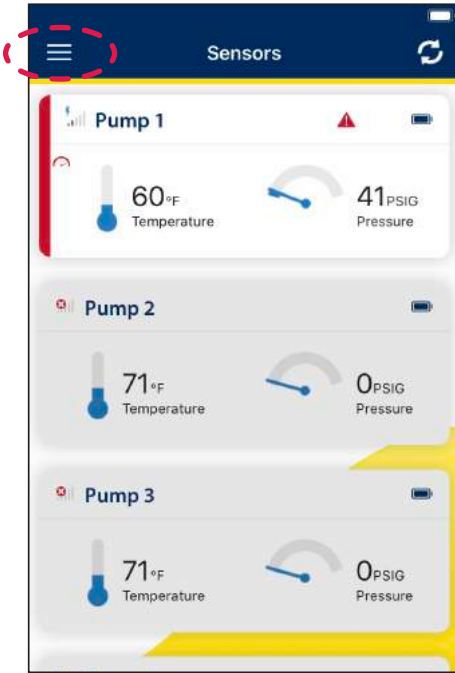

Figure 34

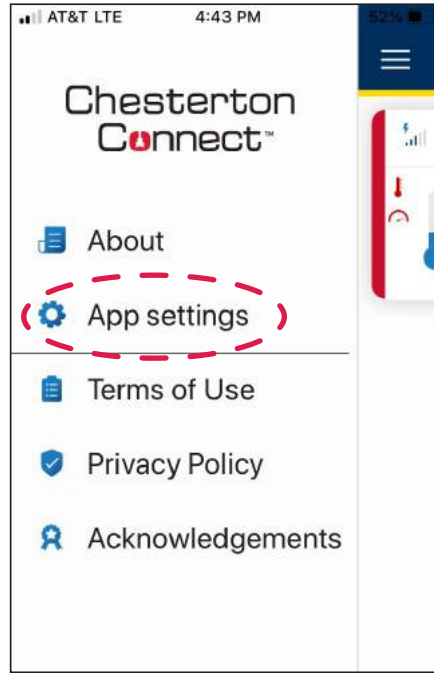

Figure 35

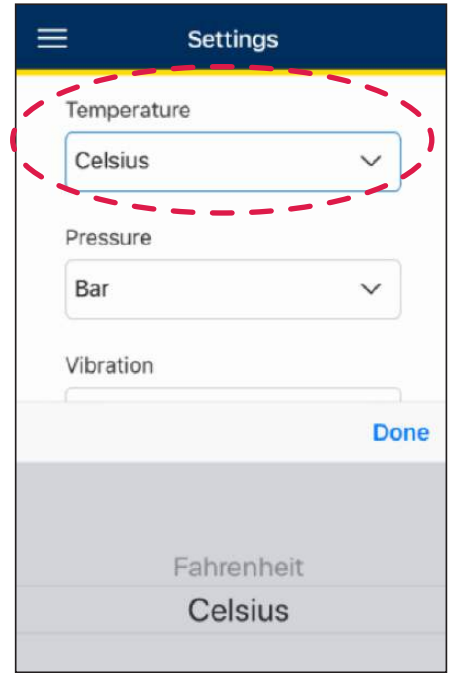

Figure 36

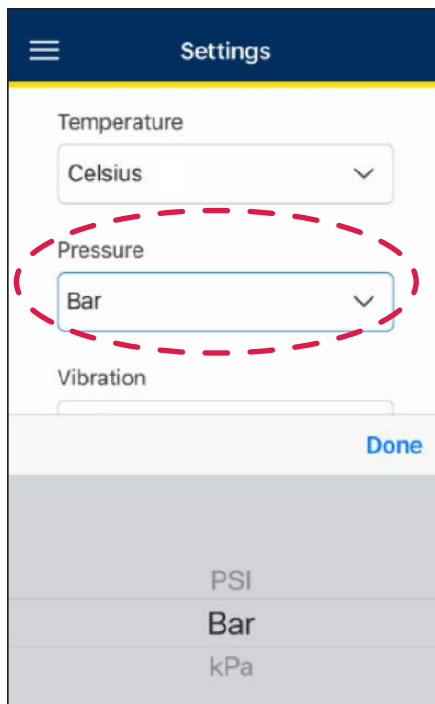

Figure 37

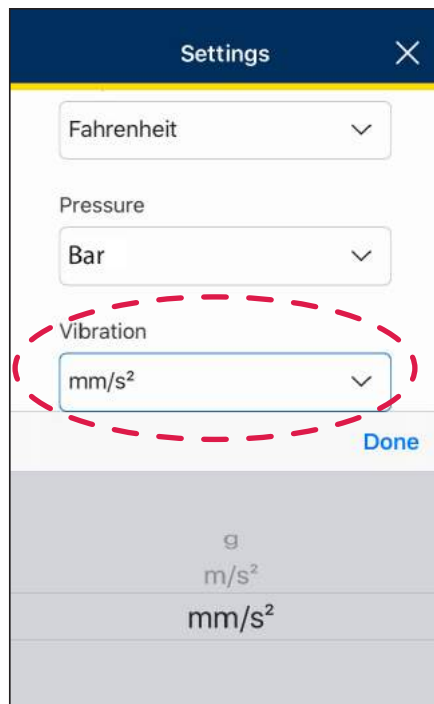

Figure 38



Figure 39

App instructions (continued)

FINDING YOUR SENSOR

A great feature of Chesterton Connect™ is the ability to locate the sensor when installed. To utilize this feature, the mobile device must be in range of the sensor, 20 m (~ 65').

1. Swipe left on the selected sensor. The **Identify** option will appear (see figure 40).

2. Tap to select **Identify**. The sensor LED alert system will blink blue three times to alert you of its location (see figures 41 and 42).



Figure 40

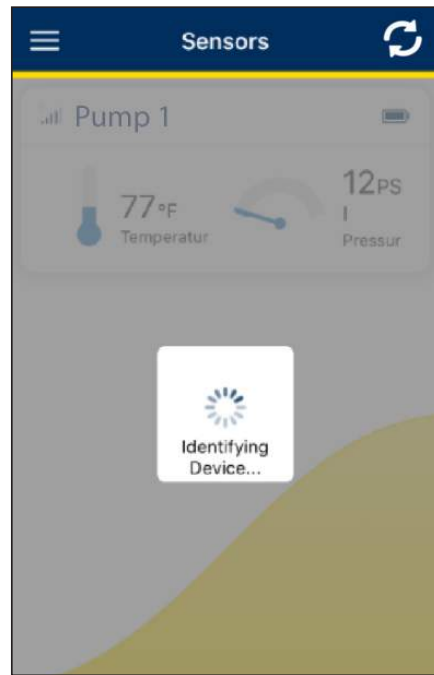

Figure 41



Figure 42

App instructions (continued)

REMOVE A SENSOR FROM THE MOBILE APP

The remove feature will only work if the sensor is out of range or powered off. **Note that deleting the sensor will remove all associated data and credentials from the App.**

1. Swipe left on the selected sensor. The **Delete** option will appear (see figure 43).
2. Select **Delete** (see figure 44).

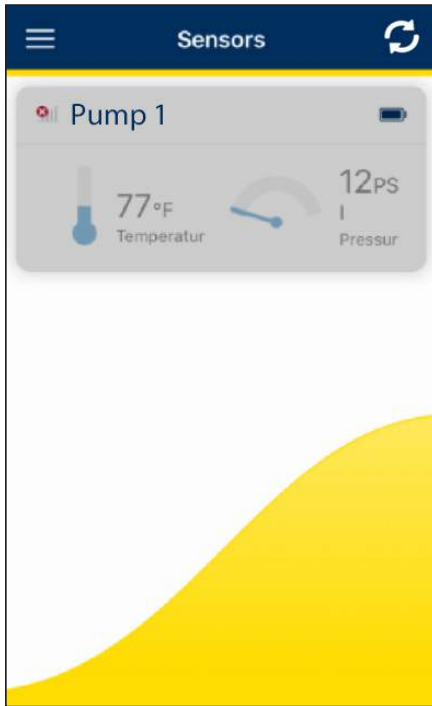

Figure 43

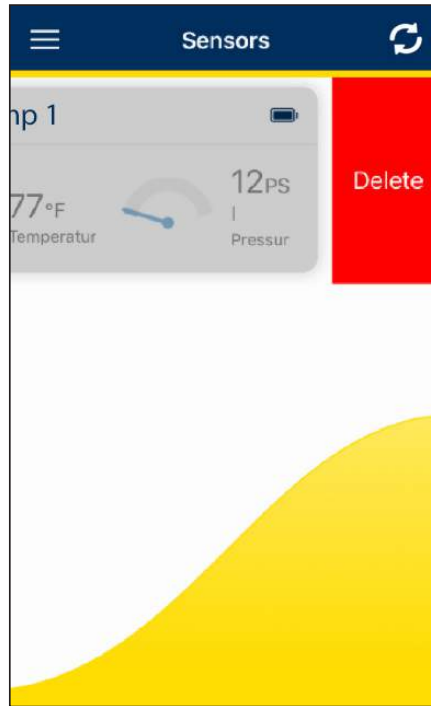

Figure 44

Troubleshooting

BATTERY REPLACEMENT

Note: Battery shall only be replaced in a clean and dry location. Avoid contact with any liquids or contaminants.

1. Disconnect the M12 pin connector from the unit.
This will deactivate the unit. Ensure P/T cable is safely secured.
2. Move the unit to a clean and dry location.
3. Once in a clean and dry location, unscrew top housing.
4. Remove the old battery. Follow local laws for proper disposal of the old battery.
5. Insert the replacement battery positive side up (see figure 5). Replace only with Chesterton battery, item number 403683.
6. Re-attach the top housing until it is finger tight.

7. Re-attach the M12 pin connector to the base unit. This will reactivate the unit. Turn the connector nut until it is finger tight. The unit will flash red, green, blue and green (again) when activated.

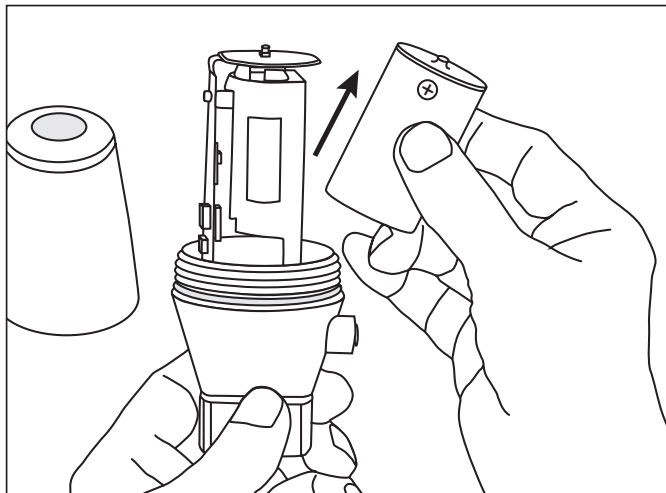

Figure 5

POWER CYCLING

Power cycling is a useful method to diagnose your sensor's operation. The unit's LED alert system will flash red, green, blue, and green (again) after performing a successful power cycle.

1. Disconnect the M12 pin connector from the unit. This will deactivate the unit. Ensure the P/T cable is safely secured.
2. Wait 5 seconds.

3. Reconnect the M12 pin connector to the unit. This will activate the unit. Turn the connector nut until it is finger tight.

Note: If the unit's LED alert system does not flash red, green, blue, and green (again) after performing a power cycling contact customer support (see page 20).

FACTORY RESETTING

A factory reset deletes all measured data stored in the unit.

To factory reset your sensor, the **M12 pin connector must stay connected**. Factory resetting shall only be performed in a clean and dry location. Avoid contact with any liquids or contaminants.

1. Once in a clean and dry location, unscrew top housing.
2. Press and hold the top "Reset" button down for 15 seconds (see figure 6). The LED will flash red and green.
3. After the LED flashes, release the "Reset" button.
4. Re-attach the top housing and turn until it is finger tight.

If you forget your password you can reset the sensor; however you will lose all measured data stored in the unit.

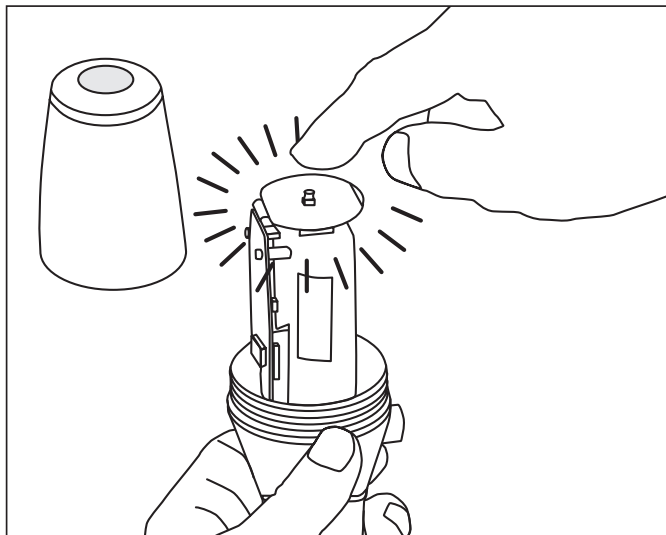

Figure 6

Limited warranty

Chesterton warrants, for a period of one year from the original date of shipment, that its Chesterton Connect™ sensor (the "Product") will be delivered free from defects in material and workmanship. Improper use of the Product, including but not limited to failure to follow instructions and warnings stated in the User Guide, accident, neglect, or abuse of the Product, or modifying the Product will void this warranty. THIS LIMITED WARRANTY IS EXCLUSIVE AND IN LIEU OF ALL OTHER WARRANTIES BY CHESTERTON, EXPRESS OR IMPLIED; TO THE FULLEST EXTENT PERMITTED BY LAW, ALL IMPLIED WARRANTIES INCLUDING BUT NOT LIMITED TO WARRANTIES OF MERCHANTABILITY, FITNESS FOR A PARTICULAR PURPOSE, COMPLETENESS OR THAT THE PRODUCT WILL MEET CUSTOMER'S REQUIREMENTS, ARE HEREBY EXPRESSLY EXCLUDED TO THE MAXIMUM EXTENT PERMITTED BY APPLICABLE LAW. CHESTERTON DOES NOT WARRANT THAT THE OPERATION OF THE PRODUCT WILL BE UNINTERRUPTED, ERROR-FREE, OR HAVE IMPENETRABLE SECURITY. USE OF INFORMATION PROVIDED THROUGH THE APPLICATION IS SOLELY AT THE CUSTOMER'S OWN RISK. IN NO EVENT SHALL CHESTERTON BE LIABLE FOR ANY DECISION MADE OR ACTION TAKEN IN RELIANCE ON ANY INFORMATION MADE AVAILABLE BY, THROUGH, OR AS A RESULT OF THE PRODUCT.

If Customer notifies Chesterton of a potentially defective Product within the warranty period above, and that Product is determined by Chesterton to be defective, Chesterton will at its option either repair, replace or refund the purchase price of that Product. Labor is not included. THE ABOVE REMEDY SHALL BE THE SOLE AND EXCLUSIVE REMEDY FOR ANY BREACH OF WARRANTY. CHESTERTON SHALL NOT BE LIABLE FOR ANY OTHER COSTS, LOSSES, EXPENSES, DAMAGES OR CONSEQUENTIAL DAMAGES INCLUDING, WITHOUT LIMITATION, ANY DAMAGES FOR LOSS OF BUSINESS OR LOSS OF PROFITS.

IN NO EVENT SHALL CHESTERTON BE LIABLE FOR ANY LOST PROFITS, LOSS OF DATA, OR BUSINESS INTERRUPTION, OR FOR ANY INDIRECT, SPECIAL, INCIDENTAL, PUNITIVE, EXEMPLARY, OR CONSEQUENTIAL OR SPECIAL DAMAGES OR LOST PROFITS HOWEVER CAUSED AND WHETHER IN CONTRACT, TORT OR UNDER ANY OTHER THEORY OF LIABILITY.

Privacy policy

To view Chesterton's privacy policy please visit:

<https://chesterton.com/en-US/Pages/Privacy.aspx>

For more information

Go to: connect.chesterton.com

Contact:

Email: connect.support@chesterton.com

833-677-7343

+1 83 367 77343

Product does not include a mobile device.

Chesterton Connect™ is a trademark of A.W. Chesterton Company.
 Android™ is a trademark of Google Inc.
 Bluetooth® is a registered trademark of Bluetooth SIG.
 iPhone® is a registered trademark of Apple, Inc.
 Google Play is a brand of Google Inc.



860 Salem Street
 Groveland, MA 01834 USA
 Telephone: 781-438-7000
 Fax: 978-469-6528
chesterton.com

© 2019 A.W. Chesterton Company
 ® Registered trademark owned by A.W. Chesterton Company in USA and other countries,
 unless otherwise noted.



Area Tecnica Srl
 Strada Banchette 3/1 - 10090 Rosta (TO)
 Tel. (+39) 011 4035367 - Fax (+39) 011 4113564
info@areatecnica.it - www.areatecnica.it

Technical data reflects results of laboratory tests and is intended to indicate general characteristics only. A.W. Chesterton Company disclaims all warranties express or implied, including warranties of merchantability and fitness for a particular purpose. Liability, if any, is limited to product replacement only. Any images contained herein are for general illustrative or aesthetic purposes only and are not intended to convey any instructional, safety, handling or usage information or advice respecting any product or equipment. Please refer to relevant Safety Data Sheets, Product Data Sheets, and/or Product Labels for safe use, storage, handling, and disposal of products, or consult with your local Chesterton sales representative.